

Simulation of basal body deformation in *Tetrahymena thermophila*

Louis Woodhams¹

Yenan Shen¹

Adam Soh²

Anthony Junker²

Chad Pearson²

Philip V Bayly¹

1. Mechanical Engineering and Materials Science, Washington University in St. Louis, St. Louis, MO, USA

2. Cell and Developmental Biology, University of Colorado Anschutz, Aurora, CO, USA

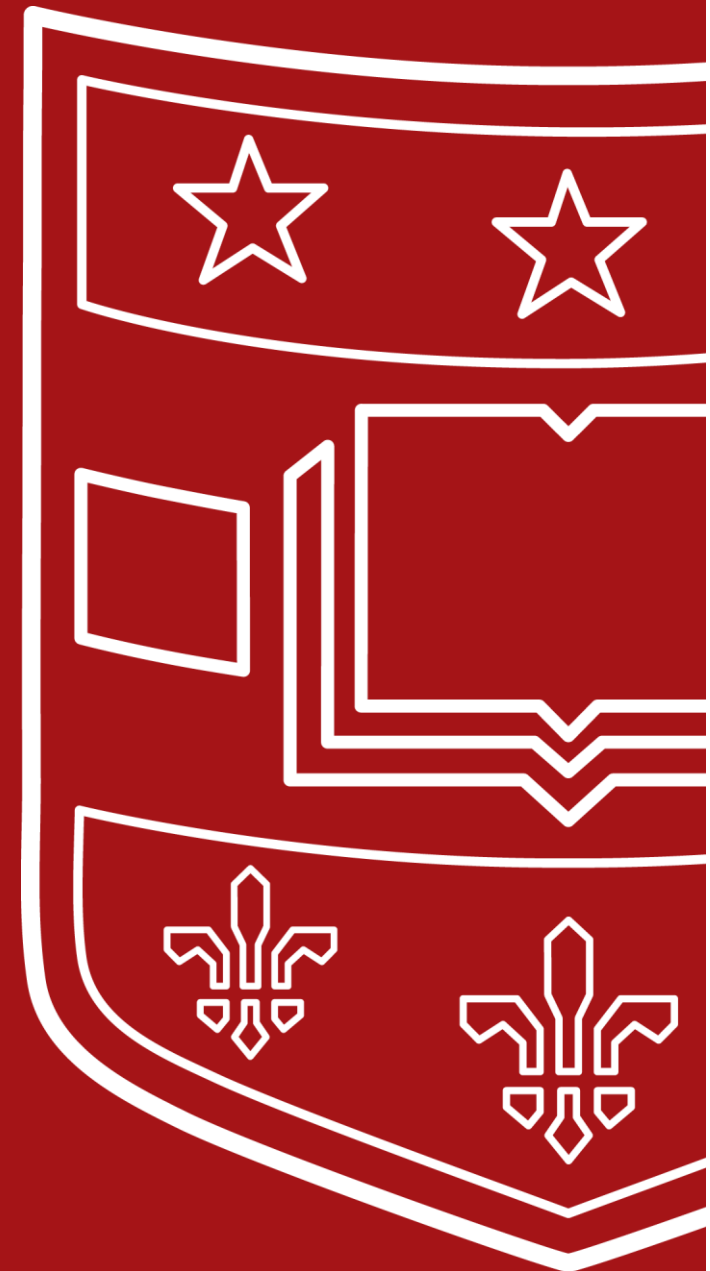



What are cilia?

- Cilia are slender whip-like cellular appendages that move fluid and propel cells

Clearing mucus in our airways

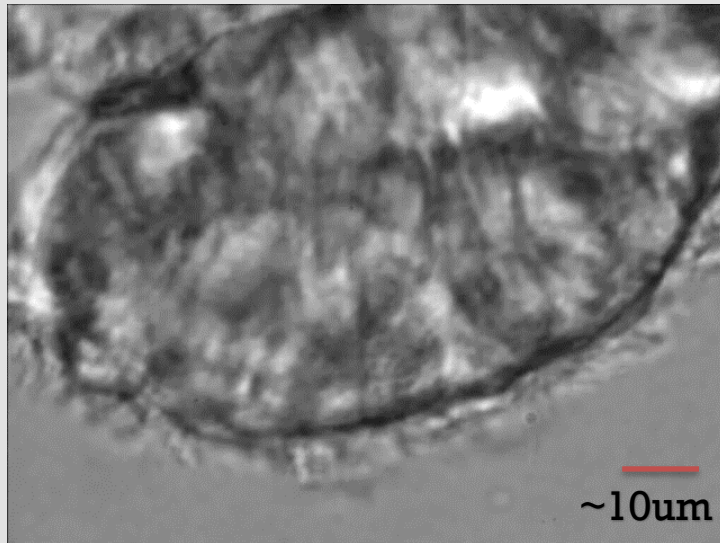

Human nasal epithelial cells
(Bottier et al. 2017)

Propelling cells in fluid

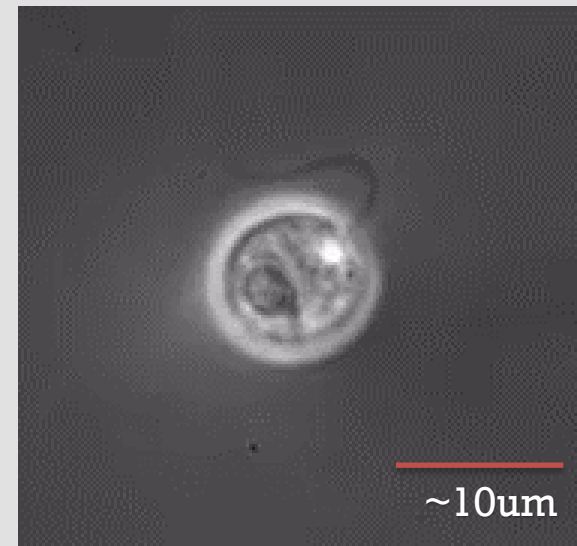

Uniciliated *Chlamydomonas reinhardtii*
Slowed 30x (Bottier et al. 2019)

The *axoneme* is an active cytoskeleton that gives cilia structure and motion

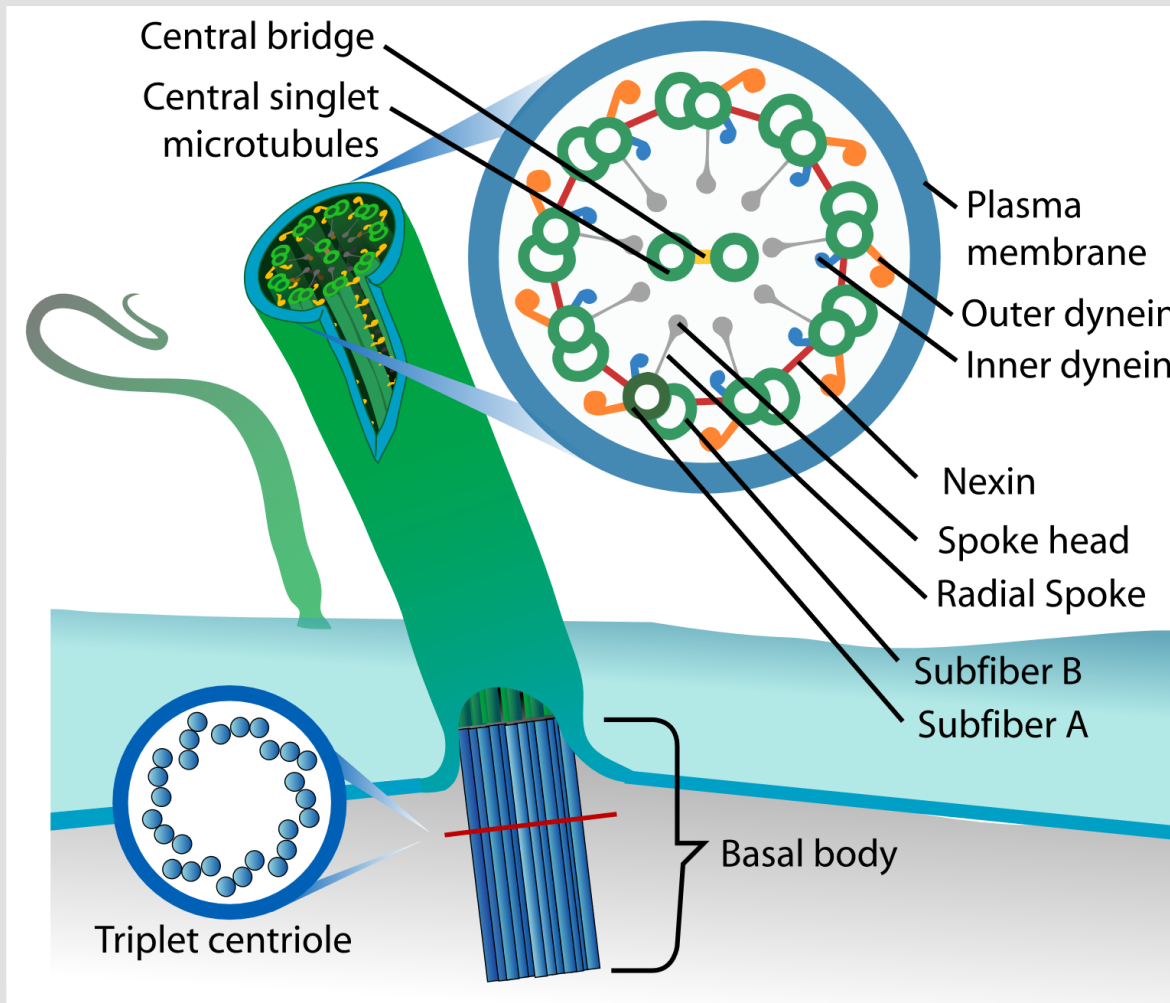

- 9 outer microtubule doublets in a cylindrical array
- Central pair of singlet microtubules
- Circumferential (nexin) links
- Radial spokes
- Dynein motor proteins
- The basal body anchors the cilium
- The basal body comprises 9 microtubule triplets inline with the doublets of the cilium



Cilia are anchored at the base by Basal Bodies (BB)

- AC linkers (AC) and a cartwheel structure (not shown) connect BB triplets near the base
- Post-Ciliary MicroTubules (pcMT), Transverse MicroTubules (tMT), and the Striated Fiber (SF) attach the BBs to the cellular cortex and other BBs.

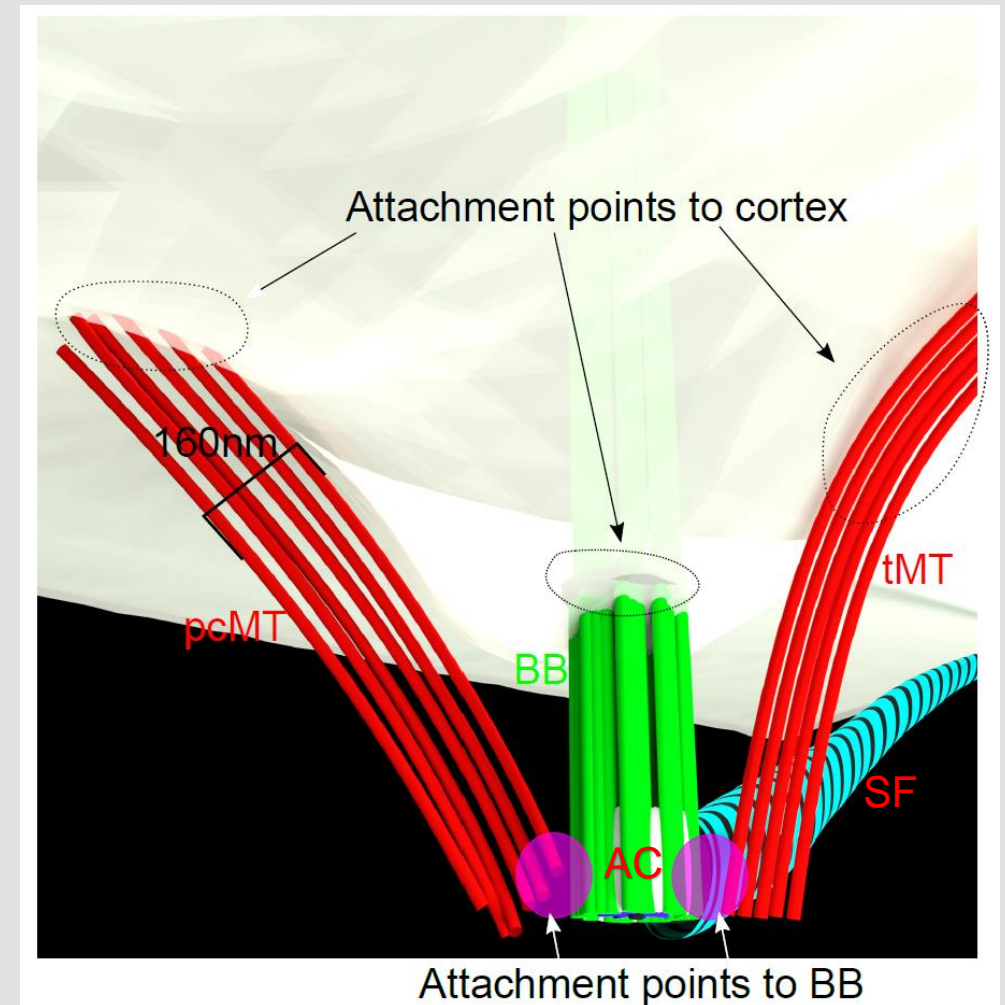



Basal bodies are not well understood

- How do BBs resist the forces of ciliary beating?
- What role do internal and external protein structures play in carrying BB loads? (e.g. AC links, Striated Fiber)
- How do mutations in proteins affect the structure and function of the BB?
- Can we gain insight into the generation of ciliary beating through analyzing deformation in BBs?

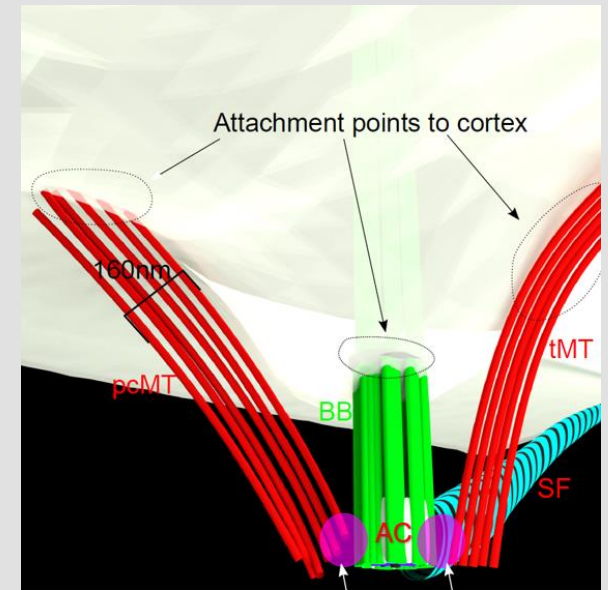



BB deformation studied by cryo-electron tomography

- Cells are frozen, sectioned, and imaged using electron tomography
- Curvature is measured along the BB triplets
- Displacements are measured at the BB proximal ends

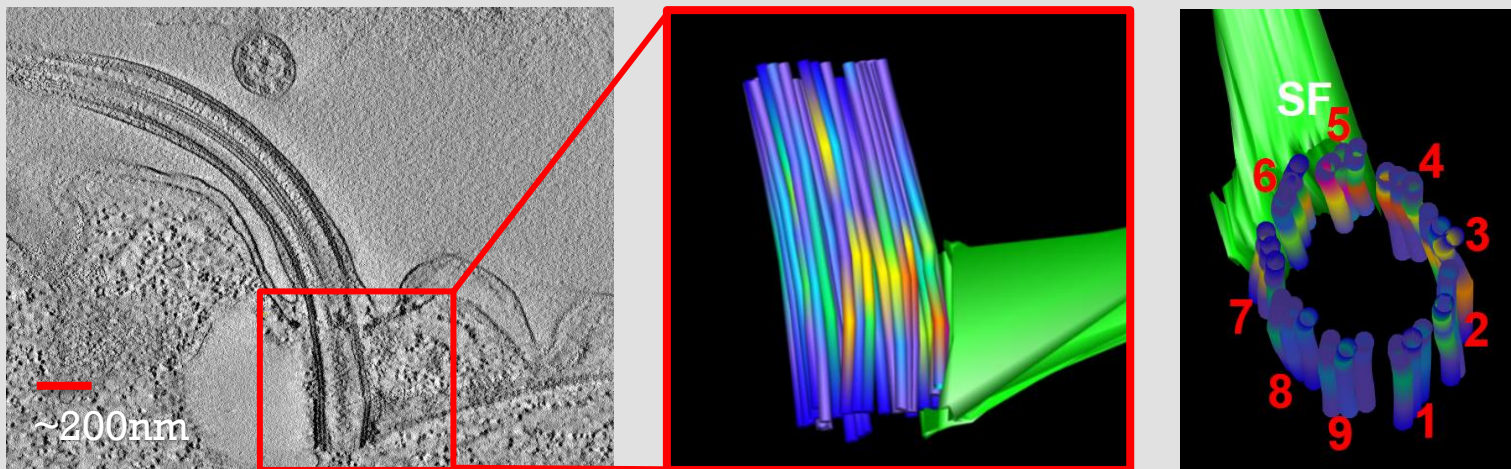



Comsol Model

- Microtubules and accessory structures are modeled as Euler-Bernoulli beams
- Elastic couplings between adjacent doublets are modeled using *extrusion couplings*
- Internal dynein forces generating ciliary beating are modeled as follower forces and moments using *edge loads*
- Fluid forces are applied using resistive force theory and beam normal and tangent vectors

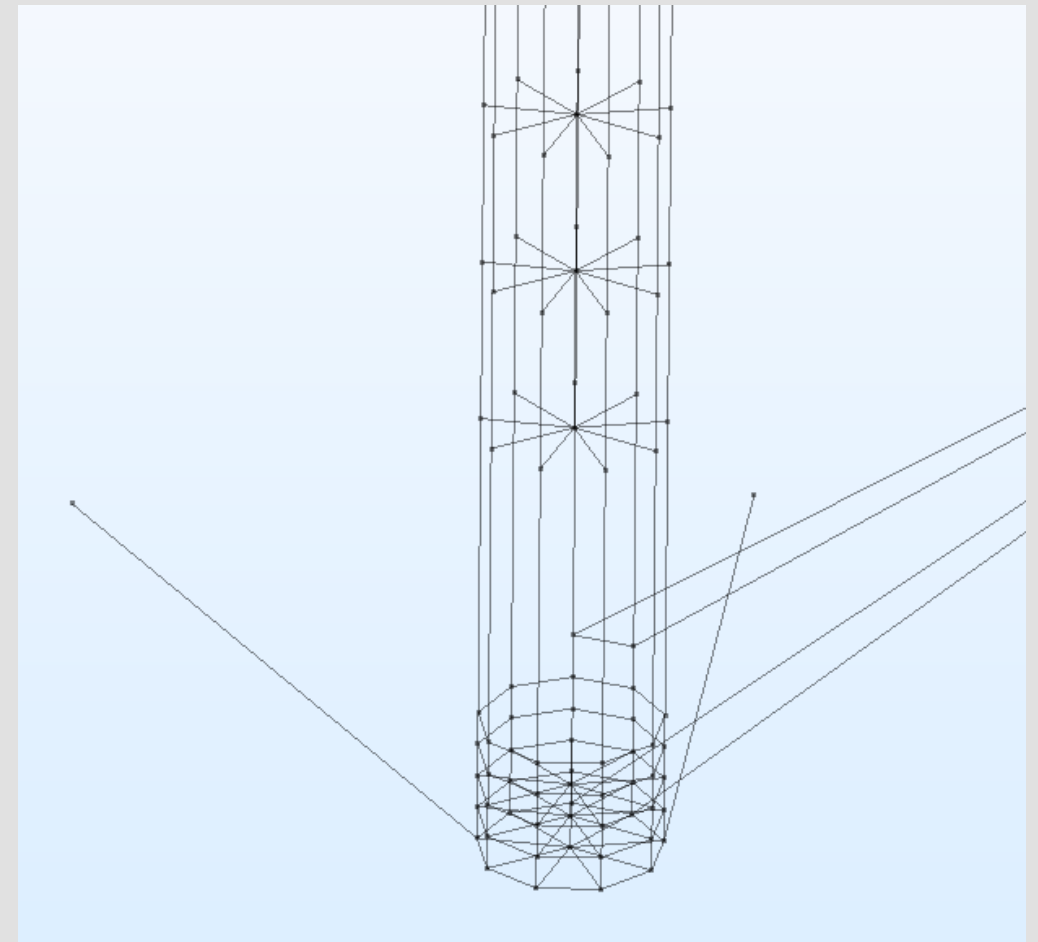



Multiple levels of complexity

- The model was initially built as a simplified model in 2D for rapid iteration and evaluation of unknown parameters
- Once the 2D model was well understood and parameters were estimated, the 3D model with greater complexity was built

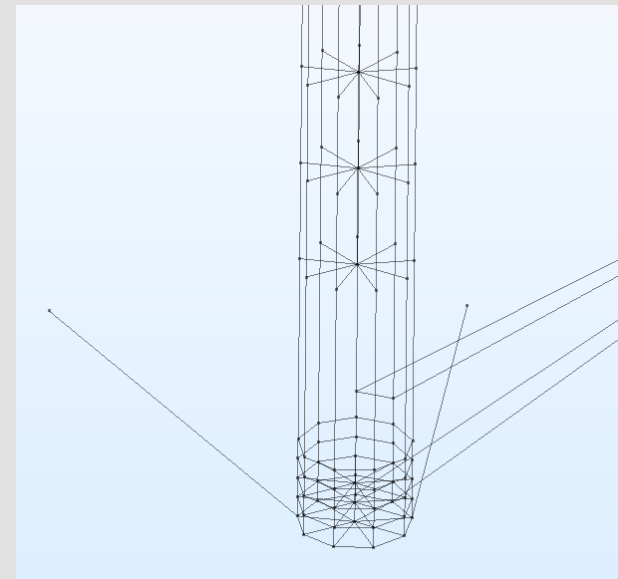
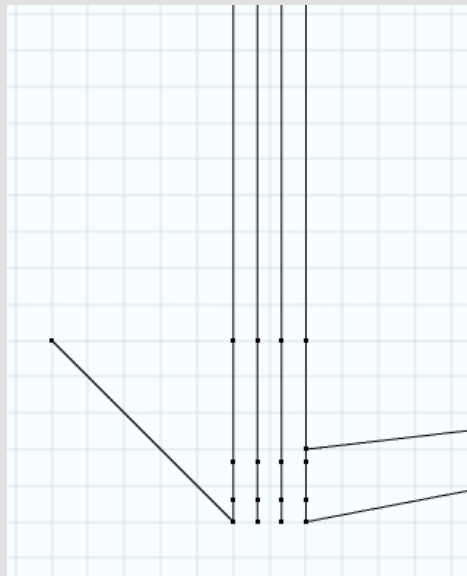



Solving the system

- This system has large deformations and significant geometric nonlinearity due to the follower loads
- Stationary solutions are obtained by stepping the load using an *auxiliary sweep* with continuation
- Time-dependent solutions were obtained using the BDF solver using either simple ramped-loads, or spatiotemporally varying loading representing different theories of ciliary beating



Results

- Deformations obtained using simulation are qualitatively similar to those observed in cilia by cryo-ET
- Quantitatively, measurements of triplet curvature and longitudinal displacement are brought in-line with observed values by trial and selection of physically plausible parameters

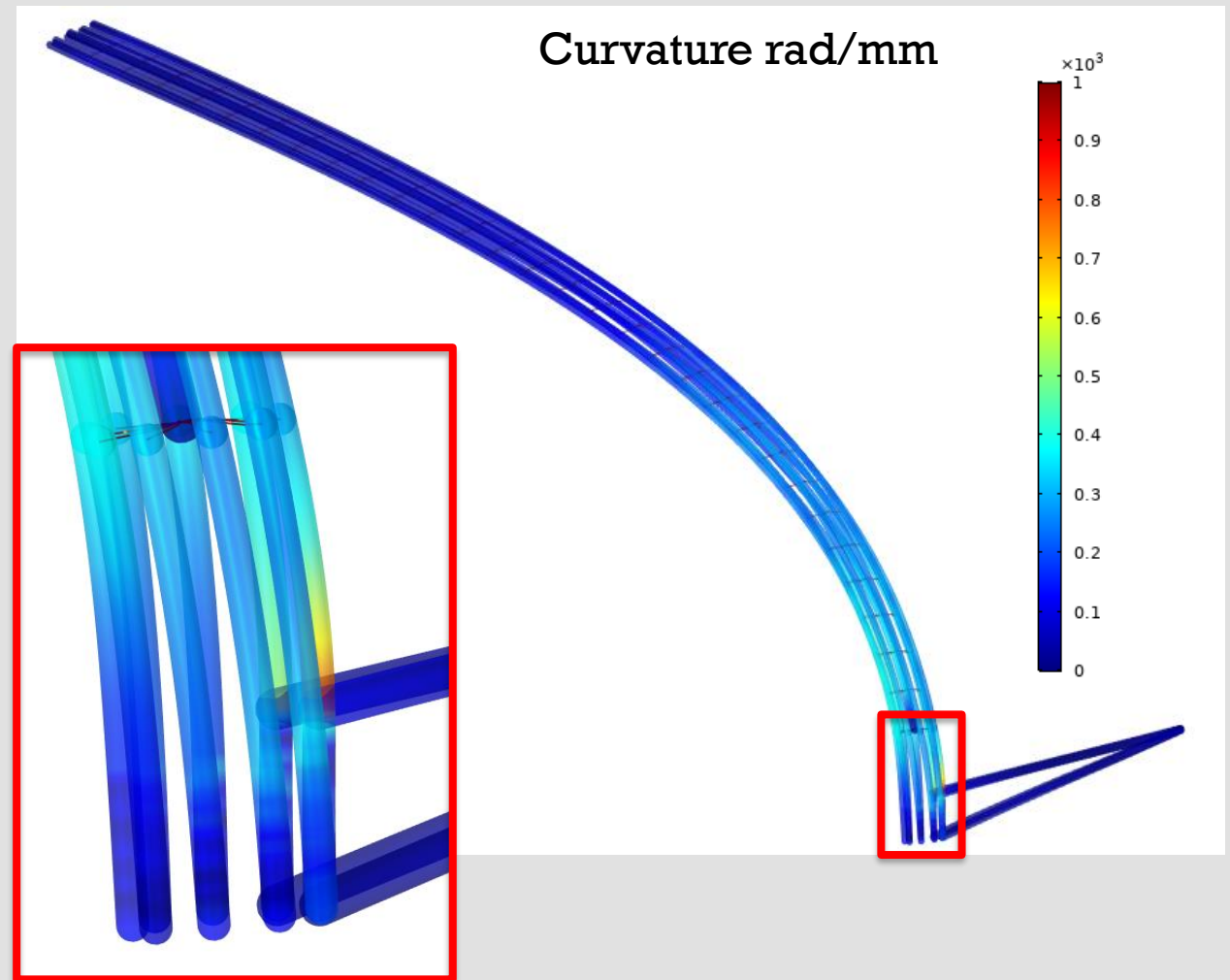

Conclusions

- Inverse modeling of BB deformations provides a powerful tool for understanding these nanoscale structures
- We can evaluate the effect of varying system parameters on BB deformation to better understand the function of individual structures in the BB
- This is still a work in progress as we improve our ability to model boundary conditions and interactions between structures

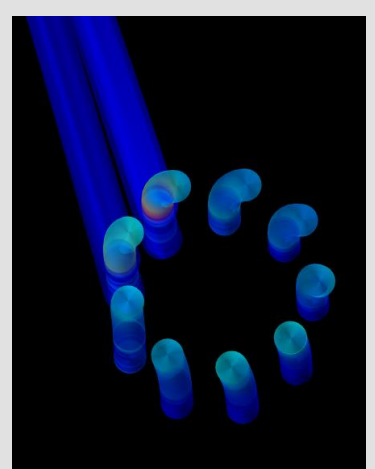
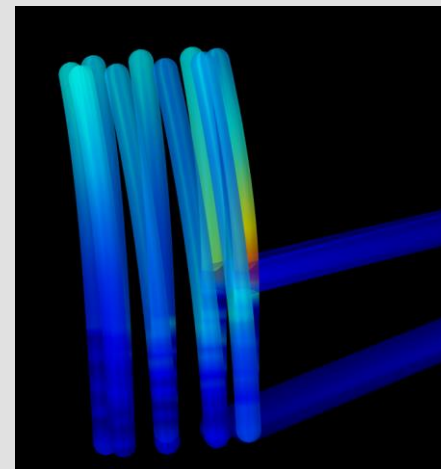
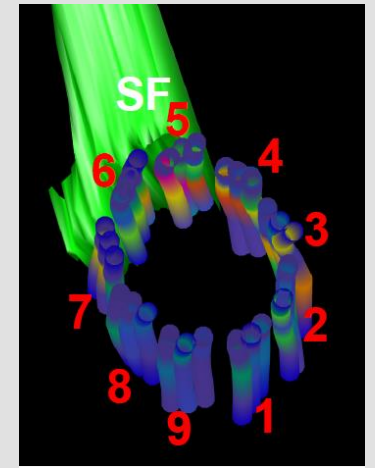
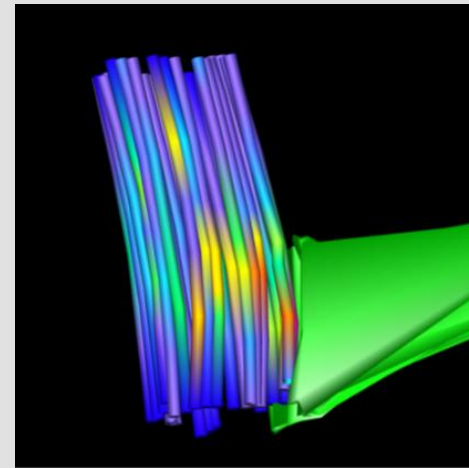

Thanks!



Funding
NSF CMMI-1633971

